

Alupex[®]
Alumínios de Excelência

**CATÁLOGO
DE
FERRAGENS**

www.alupexcomponentes.com.br



Nylon

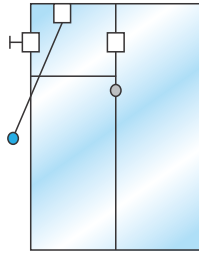

1000

Engate para corrente em alvenaria



Nylon

Latão

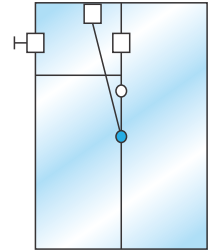

1001

Botão de correção com engate

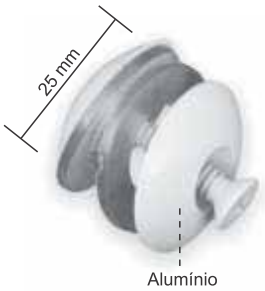

Alumínio

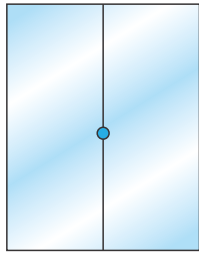

1002

Botão de correção com parafuso



Latão

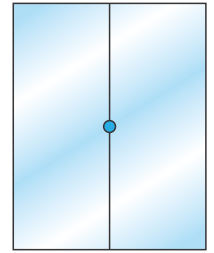

1002L

Botão de correção lâmina



Aço Zincado

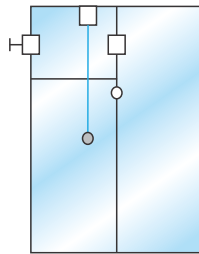

1003C

Corrente para basculante



Aço Zincado



1009

Pivô para dobradiça 1101, 1230, 1231

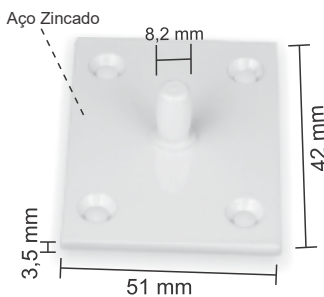

Aço Zincado

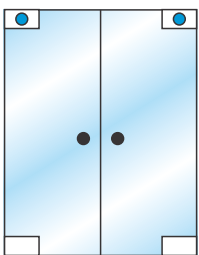

1009G

Max pivô superior para dobradiça 1101G

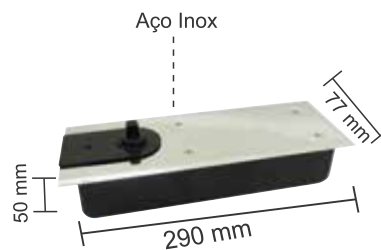

Aço Inox

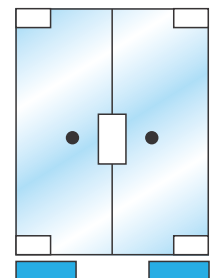

1012

Mola hidraulica de piso

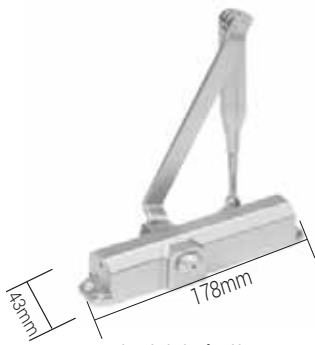

Mola hidráulica
aérea

1012S

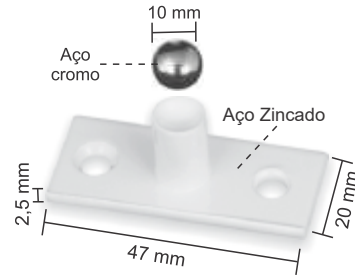
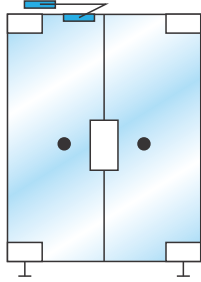

Pivô inferior para
dobradiça 1102

1014

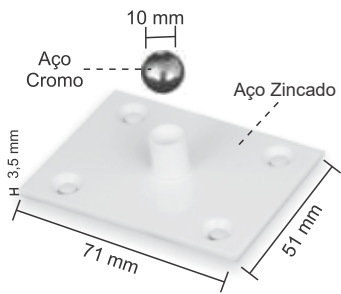
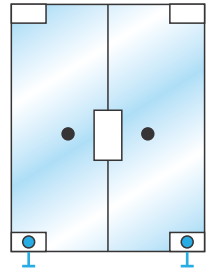

Max pivô inferior
para dobradiça 1102G

1014G

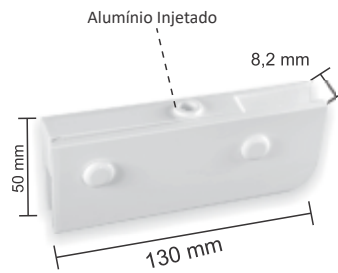
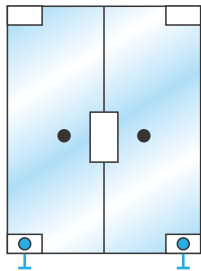

Dobradiça pivotante
superior para 1009

1101

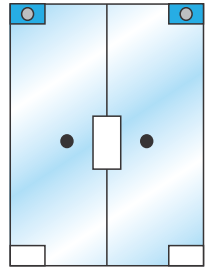

Max dobradiça
superior para 1009G

1101G

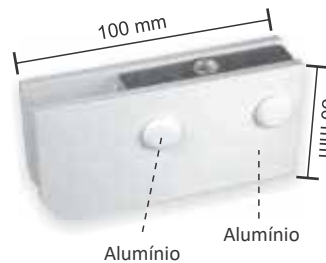
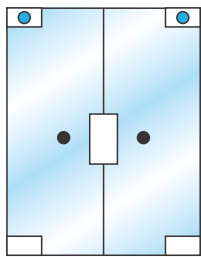

Mini dobradiça pivotante
superior para 1009

1101M

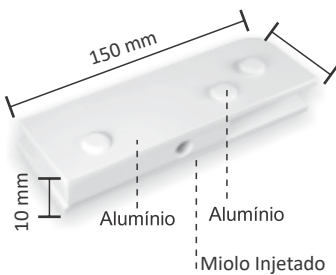
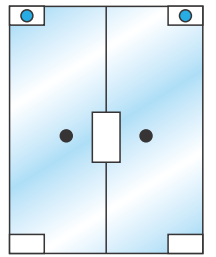

Dobradiça pivotante
inferior para 1014

1102

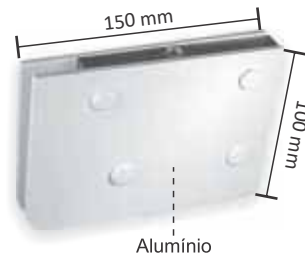
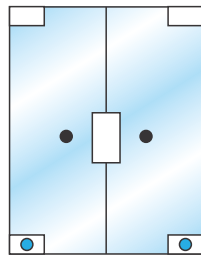

Max dobradiça pivotante
inferior para 1014G

1102G

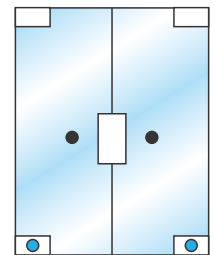

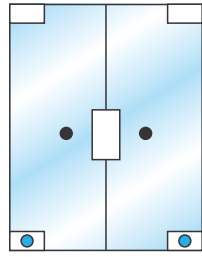
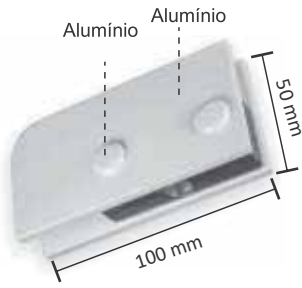

1102M

Mini dobradiça pivotante para 1014

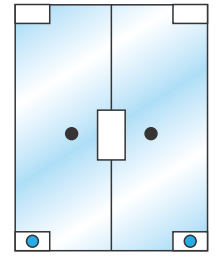
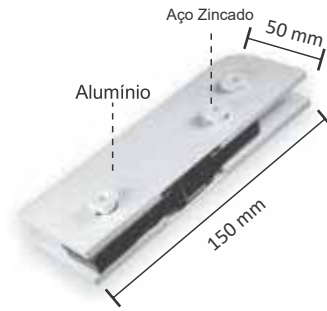

1103

Dobradiça inferior para mola de piso

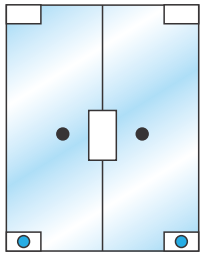
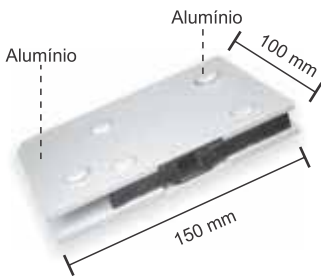

1103G

Max dobradiça inferior para mola de piso

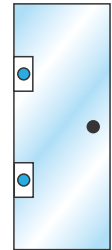
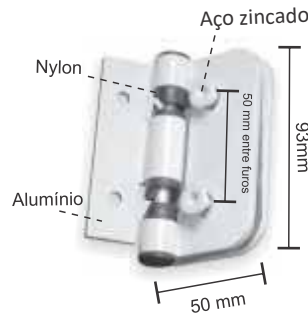

1114

Dobradiça automática para Box

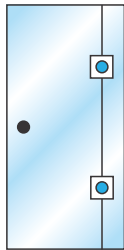
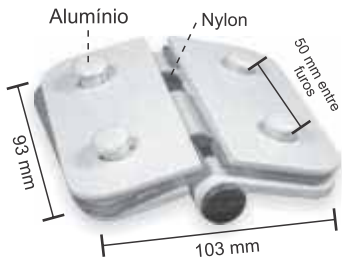

1114D

Dobradiça dupla automática direita para Box

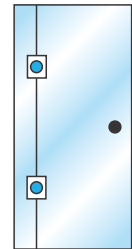
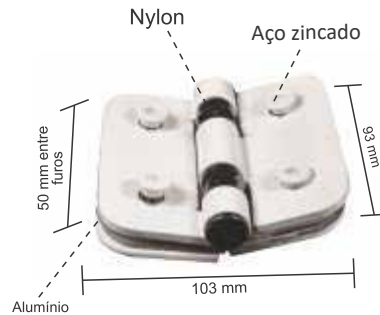

1114E

Dobradiça dupla automática esquerda para Box

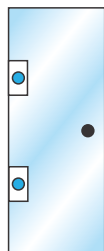

1115

Dobradiça simples para Box

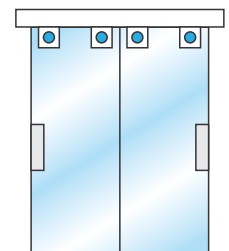

1122

Carrinho duplo para 1030 (Para portas até 80kg)

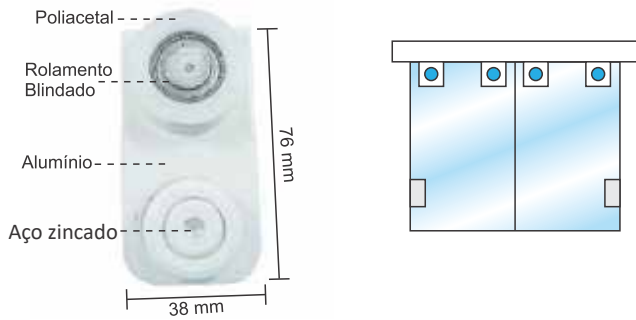

Mini carrinho simples para 1030 (1 furo, porta até 20kg)

1122M

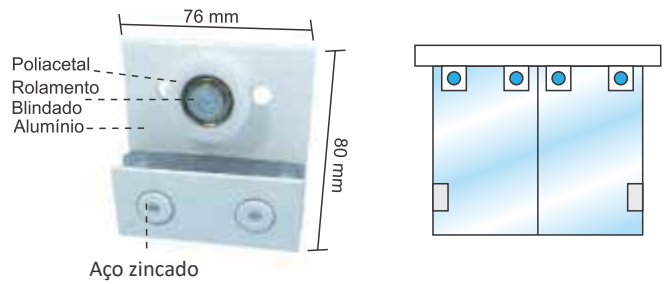

Carrinho simples para 1030 (2 furos, porta até 30kg)

1122S

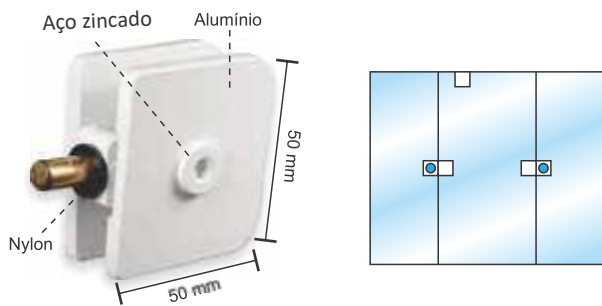

Dobradiça para basculante 50x50mm

1123

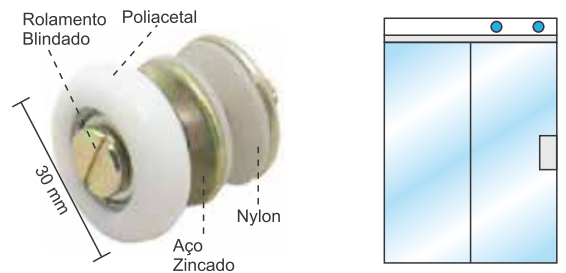

Roldana para porta e janela de correr

1125

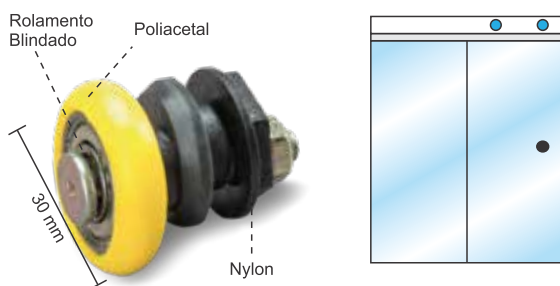

Roldana excêntrica para porta e janela de correr

1125EP

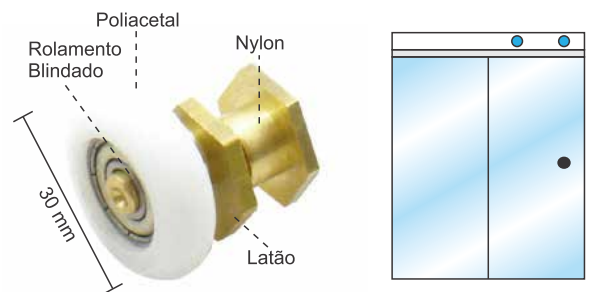

Roldana excêntrica para Box

1125ELX

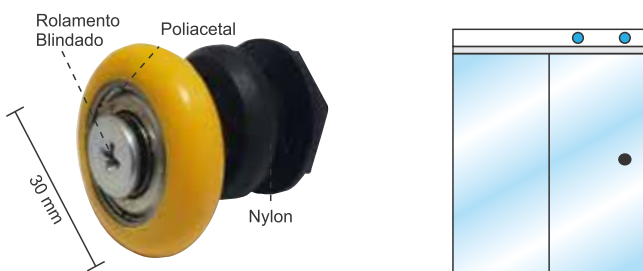

Roldana excêntrica corpo em nylon para Box

1125EPX

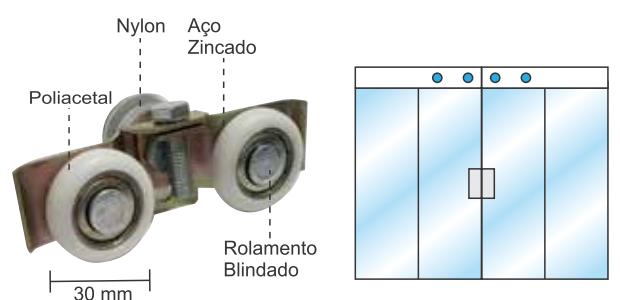

Roldana dupla com regulagem

1125DR

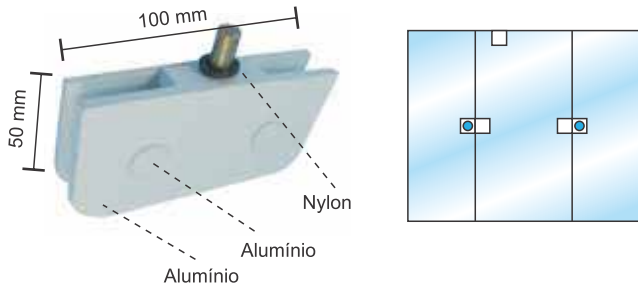

1130

Dobradiça para basculante
Com pino 50 x 100mm

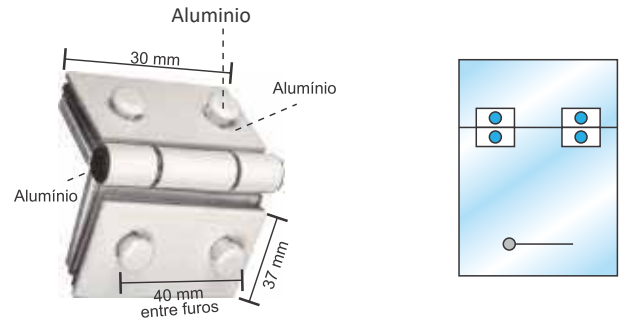

1131

Dobradiça max-ar V/V
40mm entre furos

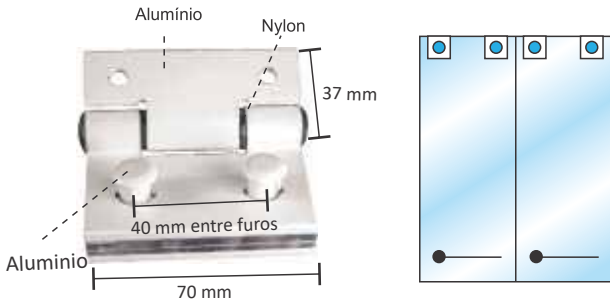

1132

Dobradiça max-ar V/A
40m entre furos

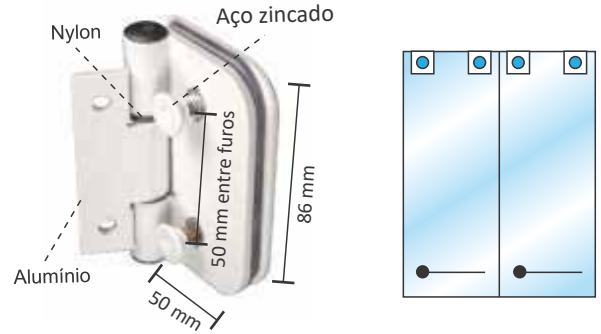

1133

Dobradiça max-ar V/A
50mm entre furos

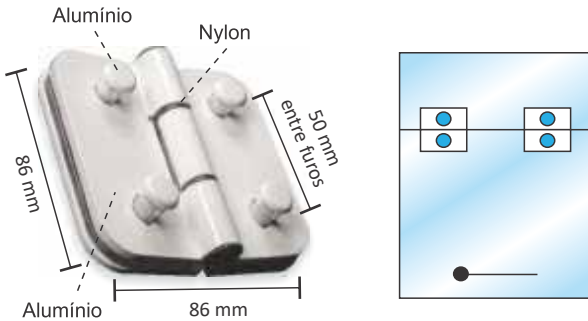

1134

Dobradiça max-ar V/V
50mm entre furos

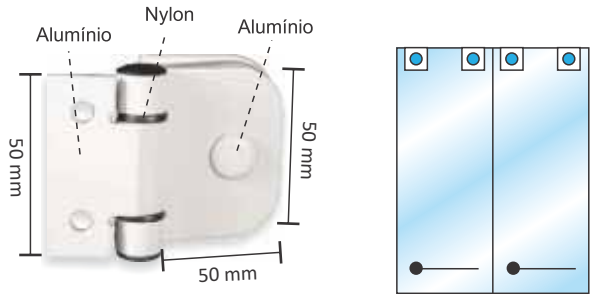

1136

Dobradiça simples
para janela

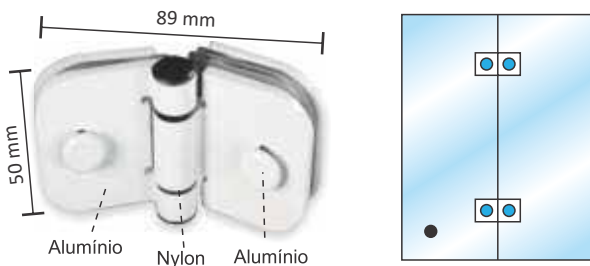

1137

Dobradiça dupla pequena
para janela

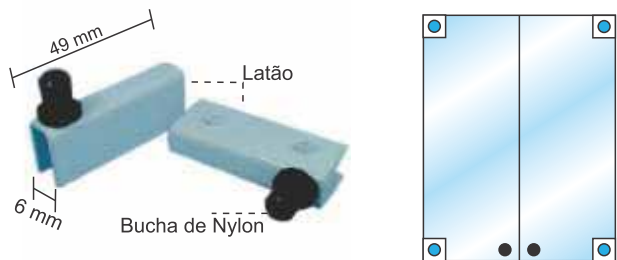

1141

Mini dobradiça pivô de
pressão (6mm) para rack

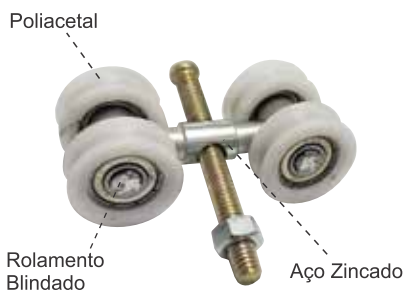

Roldana quadrupla para trilho 1030

1150



Roldana dupla para trilho 1030

1150S

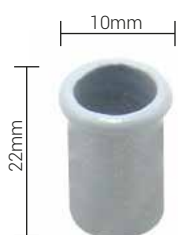

Capuxinho para trinco e fechadura

1200



Suporte de bandeira para dobradiça 1101

1203

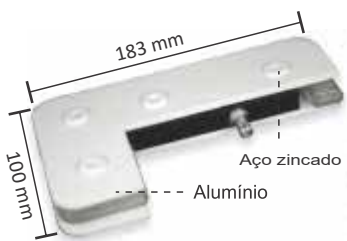

Facão simples para bandeira e fixo para 1101

1209



Dobradiça bucha para basculante 50x50mm

1230

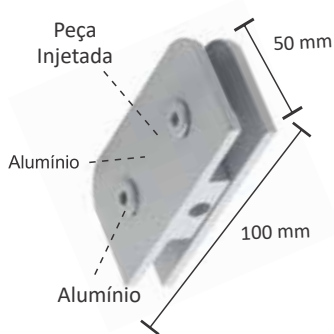

Dobradiça bucha para basculante 50x100mm

1231



Suporte de canto

1302

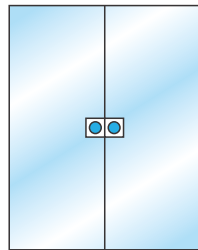

1305

Suporte central sem núcleo

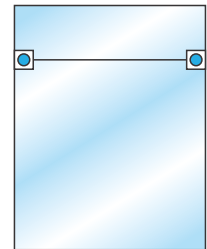

1306

Suporte para união de 2 vidros

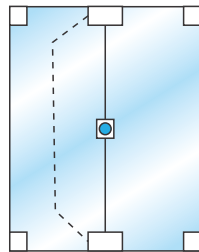

1307

Suporte sem núcleo para união de 3 vidros em T

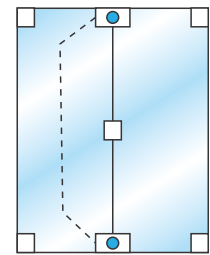
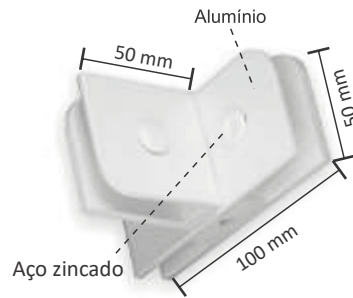

1308

Suporte com núcleo para união de 3 vidros em T

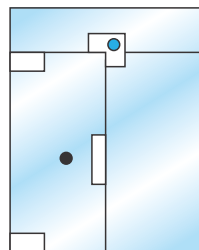
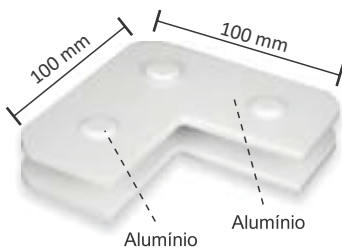

1310

Suporte sem núcleo para união de 2 vidros

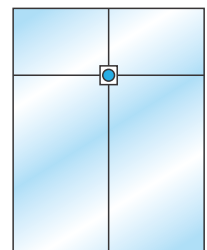
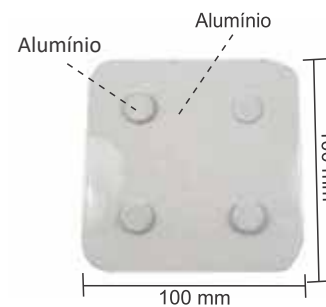

1316

Suporte sem núcleo para união de 4 vidros

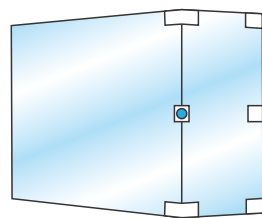
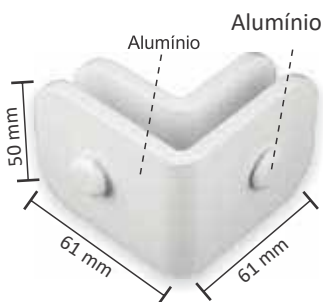

1320

Suporte central sem núcleo para uniao de 2 vidros em 90°

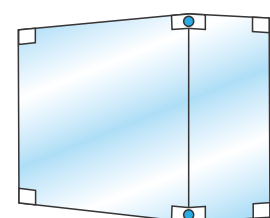
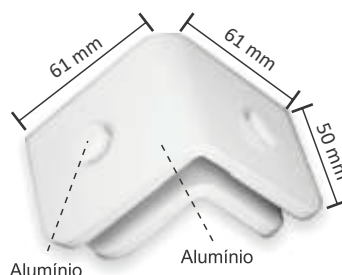

1321

Suporte piso/teto com núcleo para uniao de 2 vidros em 90°

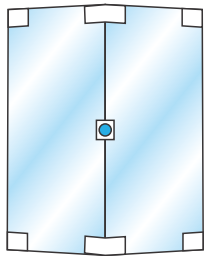
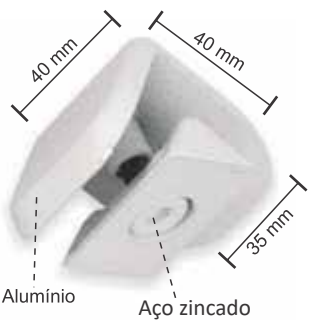

Suporte de centro com núcleo para união de 2 vidros à 90°

1322

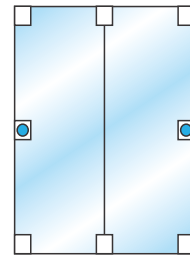
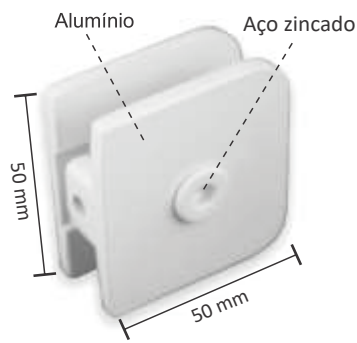

Suporte central para fixação 50x50mm

1329

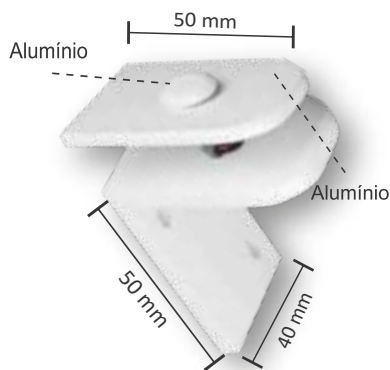

Suporte para prateleiras

1333

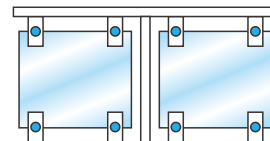
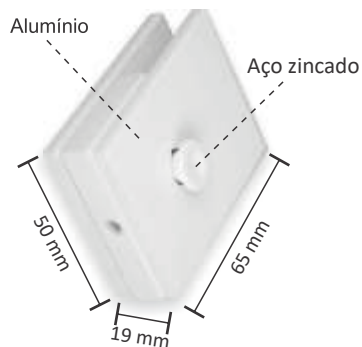

Grapa para sacada 50x65mm (Sem recorte)

1334

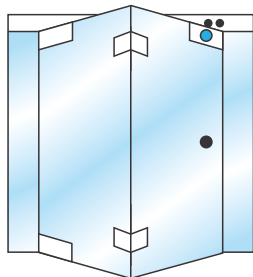

Suporte de canto com rosca para roldana 1150

1340

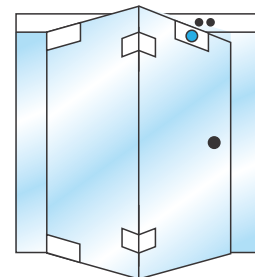
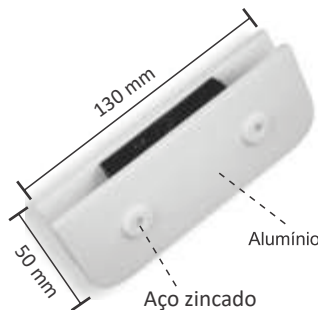

Suporte de centro com rosca para roldana 1150

1341

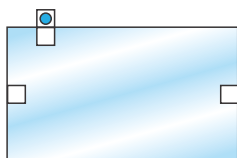
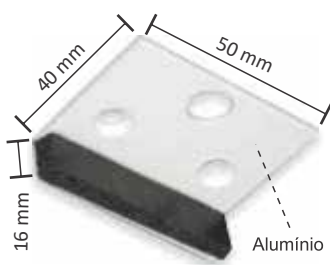

Batedeira para trinco de basculante

1400

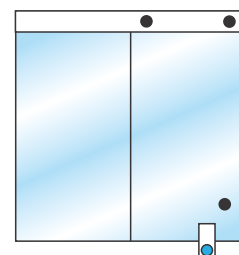
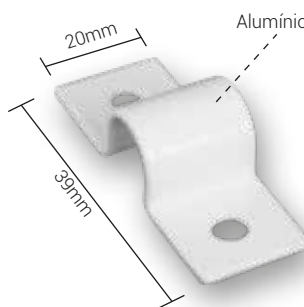

Contra trinco para 1519 e 1521

1408A

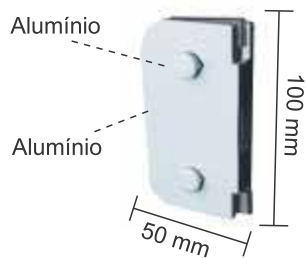

1504

Contra fechadura para 1520 e 1550

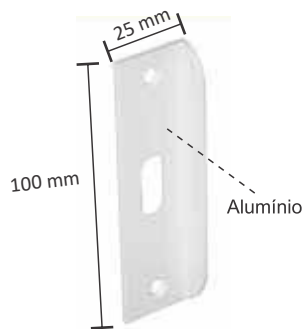
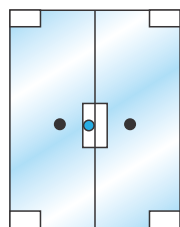

1504A

Batedeira em alvenaria para 1520

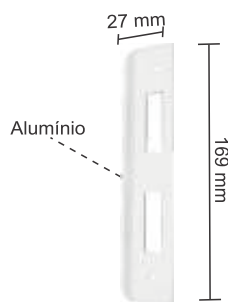
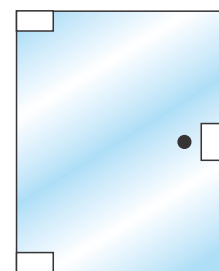

1504ATA

Batedeira universal em alvenaria para 1520TA

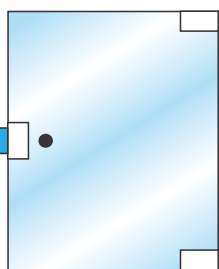

1504TA

Contra fechadura sem maçaneta universal

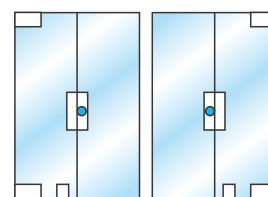

1510M

Mini fechadura com 1 cilindro para janela de correr

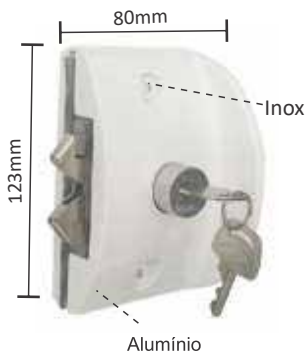
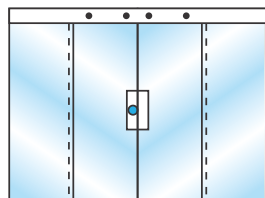

1510X

Fechadura com furação para porta de correr

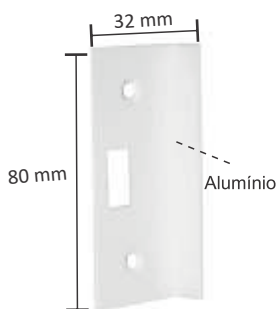
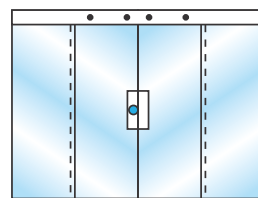

1511AM

Mini testeira para 1510M

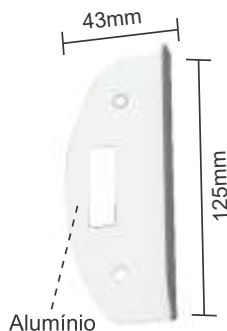
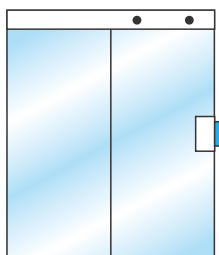

1511AX

Testeira para 1510X

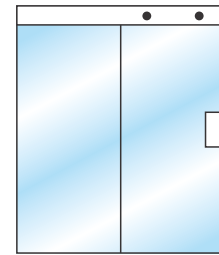

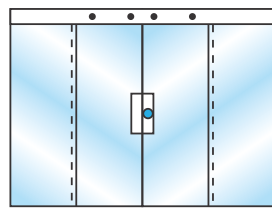

Mini contra fechadura com proteção para 1510M

1511M

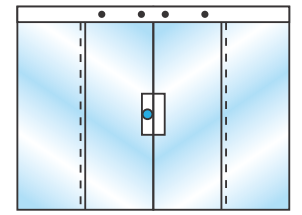

Contra fechadura para 1510X

1511X

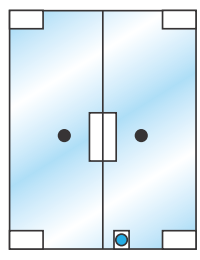

Trinco inferior sem núcleo 50x100mm

1519

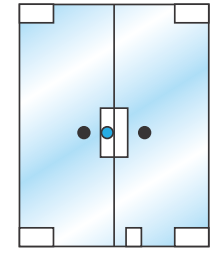

Fechadura central com 2 cilindros

1520

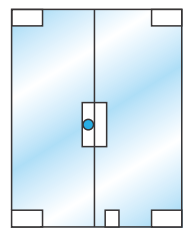

Fechadura central para maçaneta com 2 cilindros

1520TA

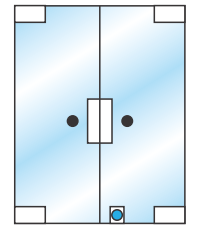

Trinco para janela ou porta

1521

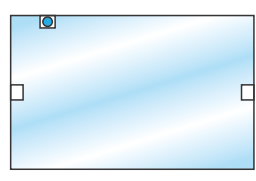

Trinco central para basculante

1523

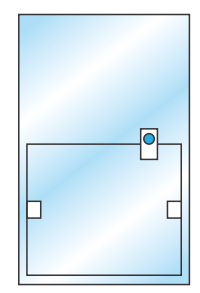

Contra trinco sem aba para 1521 e 1523

1524

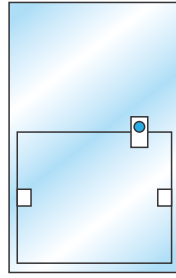

1525

Contra trinco com aba para 1521 e 1523

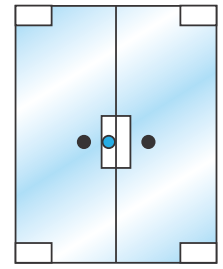
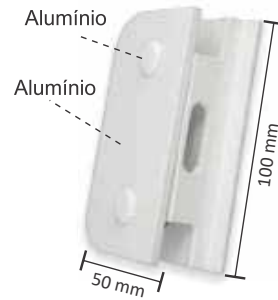

1531

Contra fechadura com batente para 1520 e 1550

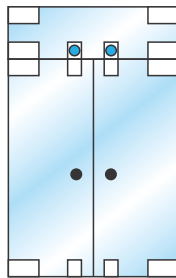
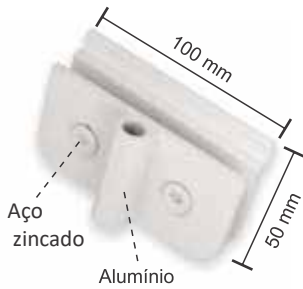

1532

Contra trinco com aba para 1519

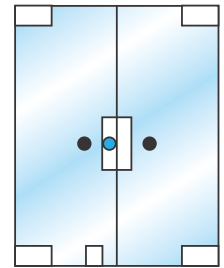

1550

Fechadura central com chave tetra

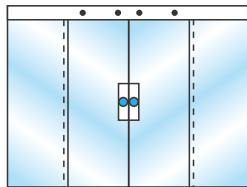

1570

Conjunto fecho V/V para janela de correr

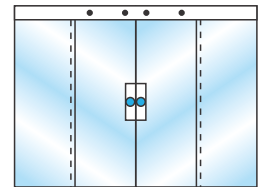

1570T

Conjunto fecho V/V para janela de correr modelo TEMPEX

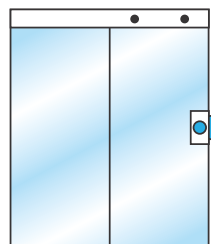

1571

Conjunto fecho V/A para janela de correr

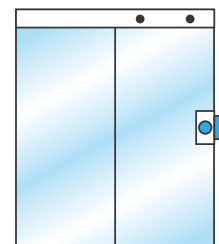

1571T

Conjunto fecho V/A para janela de correr modelo TEMPEX

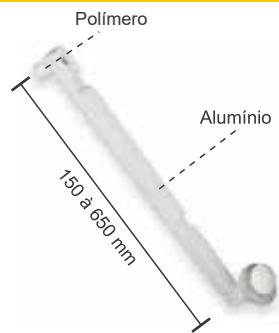

Haste para max-ar
Medidas (cm): 15 20 25 30 35 40 45 50

1587

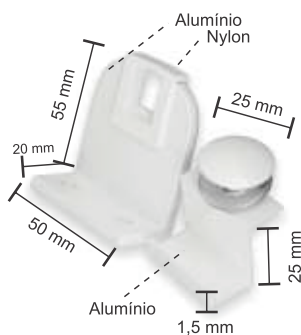

Conjunto acessório V/A
para haste 1587

1587VA

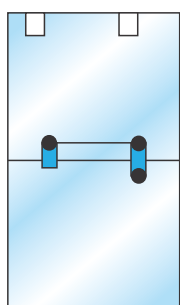

Conjunto acessório V/V
para haste 1587

1587VV

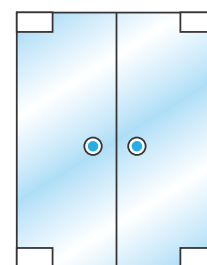

Puxador de resina
Cores: Branco, preto, incolor, fosco e bronze

1613

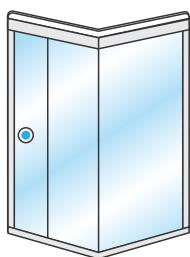
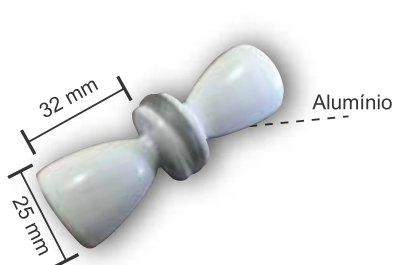

Puxador para box

1629T

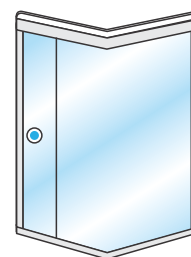

Puxador para box
frisado

1629BF

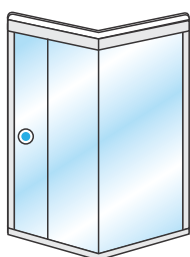
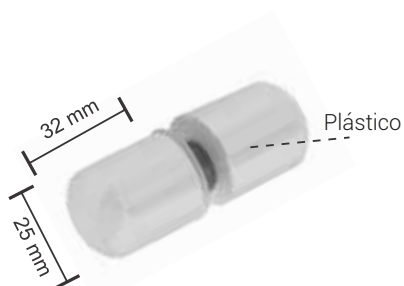

Puxador para box
plástico

1629P

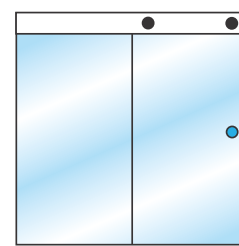

Puxador para janela
de correr (25mm)

1650

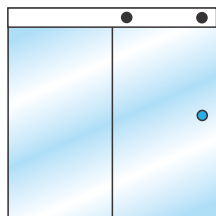

1651

Puxador para janela de correr (19mm)

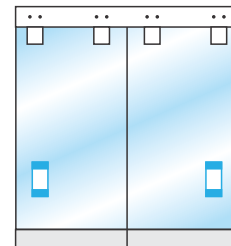
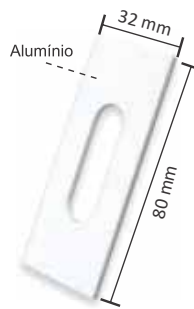

1672

Puxador autoadesivo para transpasse

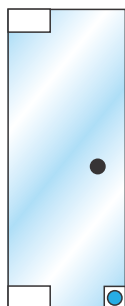

1702

Fixador de porta no rodapé

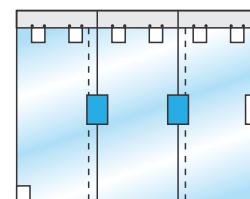

1710

Conjunto mão amiga para portas de correr

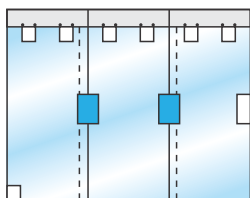
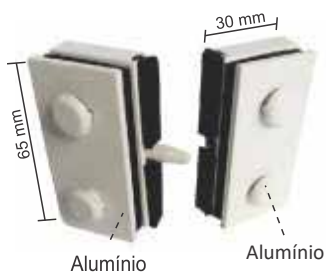

1710M

Mini conjunto mão amiga para portas de correr

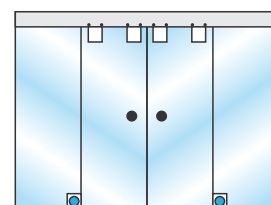

1800

Trinco para janela de correr

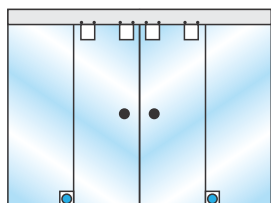

1800A

Trinco para janela de correr

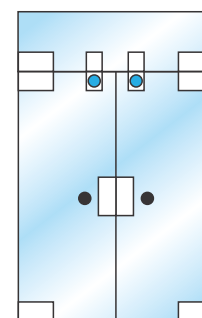

1800C

Trinco de pressão sem núcleo



Suporte de fenda

1080 - Tradicional

1080Q - Quadrado



Suporte de fenda FLEX

1079FX - Tradicional

1079QFX - Quadrado



Suporte bico de tucano

1079



Suportes para espelho

1081M - Botão francês Metal

1081P - Botão francês Plástico

1090 - Parafuso cabeça de metal



Coluna torre em Inox

Com 30cm e 2 furos

Suporte Plus

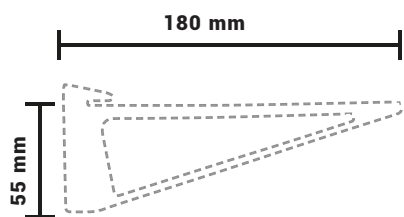

SUP-PLUS

Cap. Max. 40kg par

Profund. Max.
do tampo 300mm



Suporte Prime

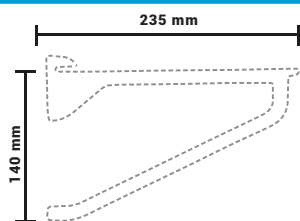

SUP-PRIME

Cap. Max. 60kg par

Profund. Max.
do tampo 500mm



Suporte plástico para espelho

SUP-ESP



Suporte para prateleira**

Disponíveis os modelos: Canto - 22x22cm
Reta - 40x10cm
Reta - 50x10cm

**Vidro vendido separadamente



Prolongadores

Diâmetros: 25mm e 40mm
Alturas: 50mm e 100mm

PRO-2550
PRO-4050
PRO-25100
PRO-40100



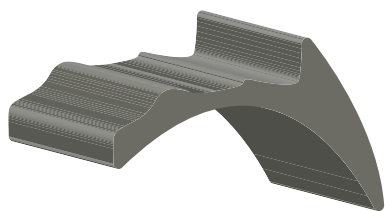

Guarnição borracha

Disponíveis os modelos: GUA-038, GUA-039
GUA-051, GUA-051A

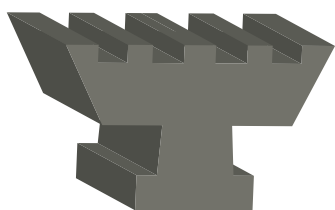

Guarnição borracha

GUA-030



Batente de borracha

1406 - Capelinha
1406B - Chato
1435 - Click (35mm)



Batente superior

1405 - Três furos
1405T - Tipo T



Batente central grande

1403

Cunha de regulagem

1401P - Pequena

1401G - Grande



Escova de vedação

Disponíveis nos tamanhos:
5x5, 5x7, 7x7.

E nas cores: Cinza e preto

1038



Silicone acético 280g

Disponíveis nas cores:
Branco, incolor e preto.

SIL1900



Adesivo fixa espelho

SIL1902



Selante PU 44

Disponíveis nas cores:
Cinza e preto.

SILPU44





Adesivo instantâneo

Tubo com 20g



Fita dupla face

Disponível nos tamanhos: 5m e 10m



Botão de silicone (un)

BOT-SIL



Compasso para corte de vidro

Com reservatório



Ventosa dupla

VENTOSA-D

Ventosa tripla

VENTOSA-T



Aplicador de silicone simples

APL-420



Aplicador de silicone tubular

APL-400



Cortador manual de vidro Beidou

COR-001



Trena curta de aço 5mx19mm





Puxador tubular

1676 Disponível nas cores: Branco, fosco, preto e bronze



Puxador tubular em S

1617 Disponível nas cores: Branco, fosco, preto e bronze



Puxador tubular reto

1679 Disponível nas cores: Branco, fosco, preto, bronze e INOX



Puxador barra chata

1679HBC Disponível nas cores: Branco, fosco, preto, bronze e INOX

Alupex®

Aluminios de Excelência

Atendimento de segunda à sexta
das 8:00 as 17:50



41 3033-6560
41 3033-6569

Rua Mandaguaçu, 125 - Emiliano Perner - Pinhais

